

FIELD AUTOTUNE

- In the configure drive menu, set Autotune to FLD
- On the keypad, press L/R for LOCAL mode
- Press RUN. Drive will begin autotuning the field.
- When the drive stops and no error message is displayed on the MMI, the autotune was successful.

ARMATURE AUTOTUNE

- In the configure drive menu, set Autotune to ARM
- On the keypad, press L/R for LOCAL mode
- Ensure that the motor shaft is not allowed to rotate
- Press RUN. Drive will begin autotuning the armature.
- When the drive stops and no error message is displayed on the MMI, the autotune was successful.
- Go to MENU LEVEL\SAVE PARAMETERS and save your settings.

SETUP PARAMETERS

Under MENU LEVEL\SETUP PARAMETERS, there are several submenus where you can enter setup parameters. They are:

Ramps, Auxiliary I/O, Op Station, Jog/Slack, Raise-Lower, Preset Speeds, Special Blocks, Field Control, Current Profile, Inverse Time, Stop Rates, Calibration, Inhibit Alarms, Current Loop, Speed Loop, Standstill, Setpoint sum 1.

ALARMS & PASSWORD

Under MENU LEVEL\ALARM STATUS, you may view the active and last alarm status.

Under MENU LEVEL\PASSWORD, you may enter a password to protect against unauthorized access to the drive setup parameters. Refer to the 590+ product manual for details.

CONFIGURE I/O

Under MENU LEVEL\SYSTEM\CONFIGURE I/O, you may connect and disconnect internal block diagram connections, to use special functions like PID, winder blocks, diameter block, etc., and to tag analog and digital I/O to selected points inside the drive to suit your application needs.

SERIAL LINKS

Under MENU LEVEL\SERIAL LINKS, you may access parameters related to Techboxes, the system port (P3), and all the PNO configuration parameters.



DC590+ DRV Series 2 Quick Start

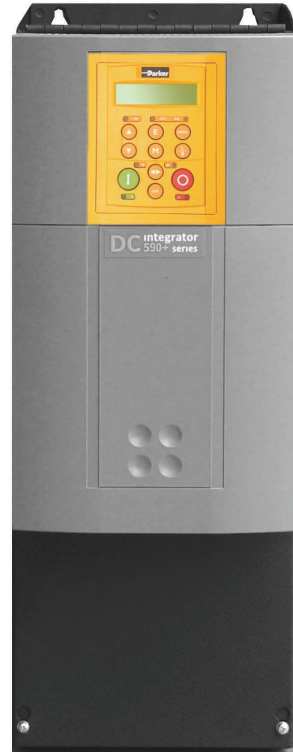

Frame 2 165 amps

Parker Hannifin Corporation
SSD Drives Division
9225 Forsyth Park Drive
Charlotte, NC 28273 USA
www.SSDdrives.com
Main (704) 588-3246 Support (704) 602-6062
HA470388U200 Issue 6

BEFORE YOU START

This document covers the steps necessary for a basic start up of the DC590+DRV drive. Drive start ups should be performed by qualified electrical technicians who are familiar with DC drives and their applications. For detailed safety, installation, advanced features and applications on the 590+, refer to the Product Manual.

Ensure that all local electric codes are met while installing the drive. Check that all live parts are covered to protect against electric shock and that unexpected rotation of the motor will not result in bodily harm or injury.

This document expects that the drive is already installed in its intended location and that all relevant installation procedures have been followed. Please ensure that the drive has adequate ventilation so that ambient temperature does not exceed 45°C (112°F) under normal operating conditions.

To access the bottom layer, slide off the bottom terminal cover and unfasten the two retaining screws. Hinge the plastic body upwards and engage the support bar.

Frame 2 (165A)

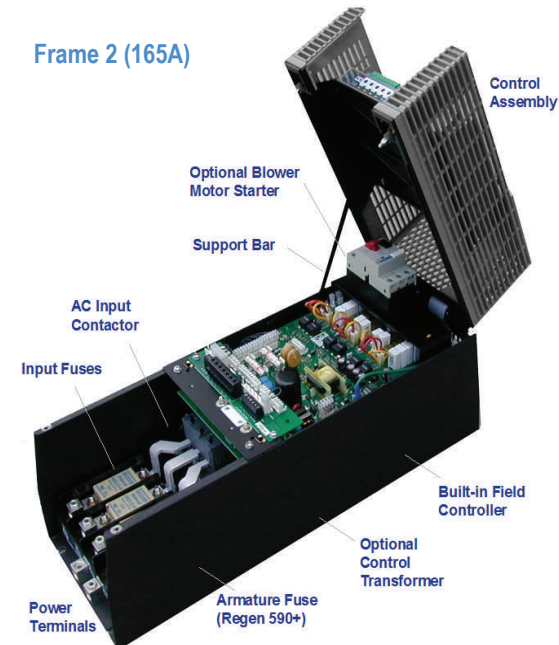

POWER CONNECTIONS

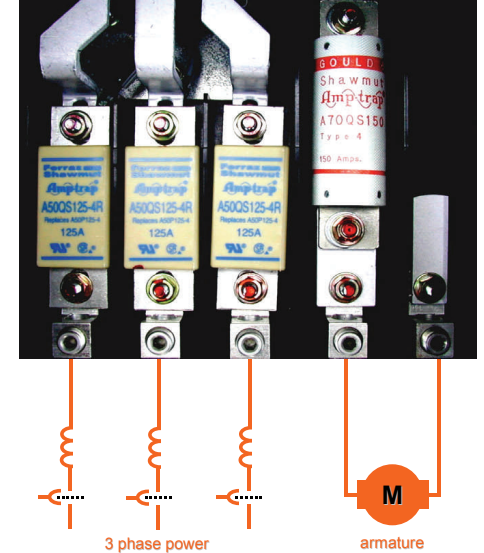

- 3-phase supply to L1, L2, L3
- Motor armature to A+, A-
- Motor fields to F+, F-
- Motor thermistor to Th1, Th2
- Control supply to L, N. Check drive nameplate for correct aux voltage supply rating
- Blower to BL1, BL2, BL3, if fitted

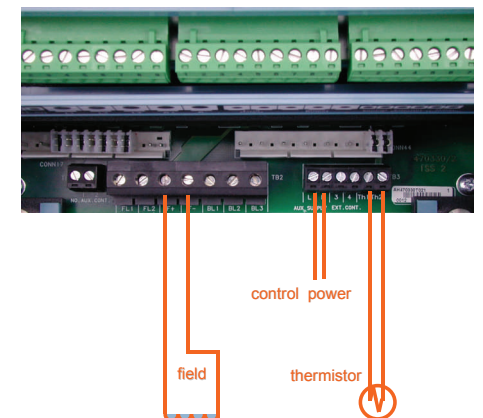

REFERENCE

SEQUENCING

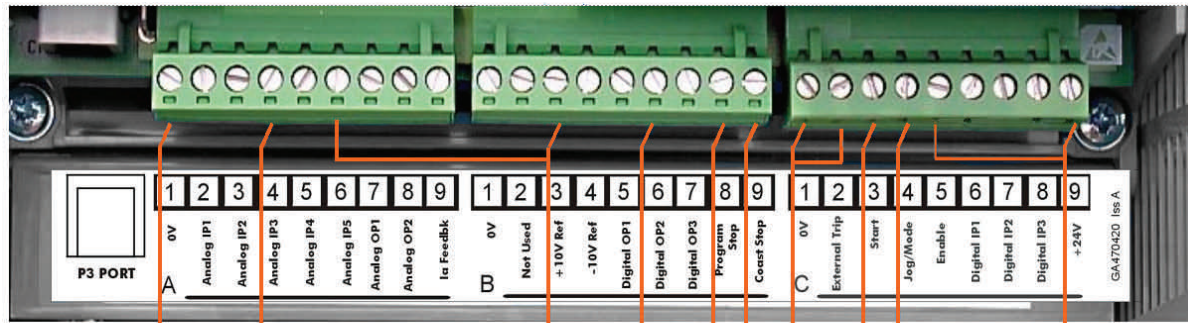

SPEED REFERENCE

- Speed potentiometer across A1 (low), B3(high), A4(wiper) OR
- External 2-wire speed reference between A1(-) and A4(+)
- Jumper A6 to B3

- E-Stop relay n.o. contact between B8, C9
- E-Stop relay n.o. TDD contact between B9, C9
- Jumper C1 and C2 if no external trip contact
- Jumper C5 and C9 for internal enable contact
- Start contact between C3 and C9
- Jog contact between C4 and C9
- Health relay coil (24V) between B6(+) and C1(-)

SPEED FEEDBACK

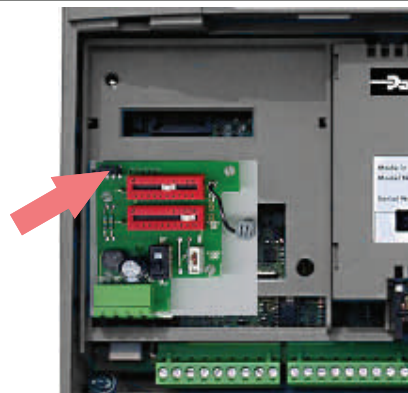

- Armature Voltage is the default speed feedback mode and does not require a feedback card.
- Four feedback cards are available. Analog Tach, encoder, acrylic microtach and glass microtach.
- Select the correct feedback card. Install it on the feedback header, shown by the arrow in the figure. Ensure all standoffs are securely snapped in place
- On the analog tach card, set switch settings in Units, Tens and Hundred, corresponding to tachometer output voltage at maximum speed
- DC Analog Tach: G3(+), G4(-). Set switch to DC
- AC Analog Tach: G1, G2. Set switch to AC
- Encoder: E1=0V, E2=+, E3,E4=A, \bar{A} , E5,E6=B, \bar{B}
- Microtach: C1=0V, C9=24V, F1=fiber optic receive

CALIBRATION

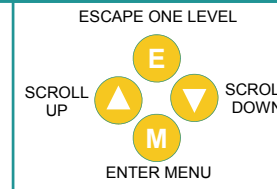

All calibration is done in software, through the keypad.

The DC590+ can also be calibrated using the programming tool software.

DIGITAL DC DRIVE
DC 4Q 34A

M DC 4Q 34A
MENU LEVEL

M MENU LEVEL
DIAGNOSTICS

▲ MENU LEVEL
CONFIGURE DRIVE

M CONFIGURE DRIVE
CONFIGURE ENABLE

▼ NOM MOTOR VOLTS

▼ ARMATURE CURRENT

▼ FIELD CURRENT

▼ FLD. CTRL MODE

▼ FLD. VOLTS RATIO

▼ MAIN CURR-LIMIT

▼ AUTOTUNE

▼ SPEED FBK SELECT

▼ ENCODER LINES

▼ ENCODER RPM

▼ ENCODER SIGN

▼ SPD. INT TIME

▼ SPD. PROP GAIN

This is the power-up welcome screen

Press the M key to get to MENU LEVEL

Press M. You are in MENU LEVEL, at DIAGNOSTICS

Up arrow to get to CONFIGURE DRIVE menu

Press M and up arrow to ENABLE drive configuration
All 7 LEDs blink in Configuration mode. Press E when done

Using the Up & Down arrows, enter rated motor voltage

Enter rated motor armature current

Enter rated field current. Skip if field is in Voltage mode

Toggle between voltage and current modes

If in voltage mode: Ratio = (field volts/AC supply)*100
Example: For a 300V field and 460V supply: Ratio = 300/460*100 = 65%

Enter desired current limit setting. Usually 100%

Leave this OFF. Autotune after calibration is complete

Choose from Armature Volts/Analog Tach/Encoder

Enter the pulses per rev. rating of the encoder

Enter the max speed here. Corresponds to 100% speed

Change the polarity of the encoder signal

Speed loop integral gain

Speed loop proportional gain

- Set CONFIGURE ENABLE to DISABLE. The drive will display "CALIBRATING"
- Under MENU LEVEL/PARAMETER SAVE, press the M and UP to save your settings

POWER ON